

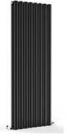















# GIO INSTALLATION GUIDE

This product must be fitted only by a fully qualified installer.

Description	Illustration	Qty
Radiator		1
Top Bracket		2
Bottom Bracket		2
Fixing Screw		4
Spacer		4
Air Vent		2
Vent cover		2

Description	Illustration
Fixings choose the appropriate fixing for the wall material if required	
PTFE tape	
Electric drill	
Masonry drill bit appropriate to the fixings	
Adjustable spanner	
Radiator valve Hex Key	
Flat head and Philips head screw drivers	
1 Lock shield valve and 1 Gate or Thermostatic valve	
Spirit level	
Measuring tape	

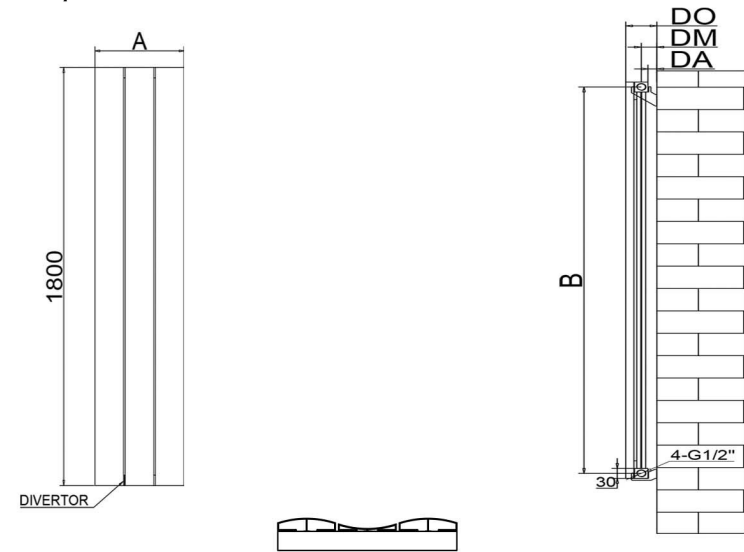

This picture represents appearance look of a radiator.

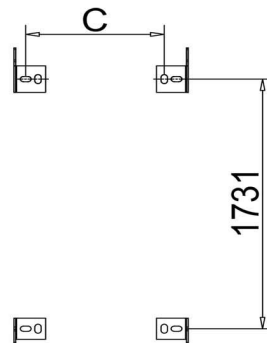
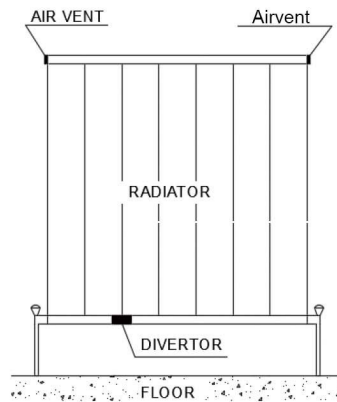







NAMES		A	B	C	TUBE QTY	DA	DM	DO
A-GI318A	1800	280	1770	57.5	3	20	35	70
A-GI318W	1800	280	1770	57.5	3	20	35	70
A-GI518A	1800	470	1770	247.5	5	20	35	70
A-GI518W	1800	470	1770	247.5	5	20	35	70
A-GI718A	1800	660	1770	437.5	7	20	35	70
A-GI718W	1800	660	1770	437.5	7	20	35	70









## GENERAL RECOMMENDATION

- Before fitting the radiator it is necessary to wash out the heating system to remove any existing mud, scale, work residues, traces of flux, oil, etc.
- When the system water pH is outside the 8,5-5,5 range and/or when the dissolved is above 0,1mg/liter, it is always needed to protect the heating system components (the radiator is one of these) with a proper chemical treatment compatible with all parts in contact with water (silicon rubber too).
- In order to fit the radiator to the wall, it is necessary to choose the proper fixings for the wall material.
- If the system water exceeds °50C, please install a warning mark near the radiator to avoid any accidental scalding.
- Clean the radiator surface only with a soft cloth to avoid scratching the finish and do not use chemical agents during cleaning operations. It is prohibited to climb on the radiator.
- Maximum working temperature °95C, maximum working pressure 4 bar.

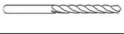
# GIO INSTALLATION GUIDE

This product must be fitted only by a fully qualified installer.

Description	Illustration	Qty
Radiator		1
Top Bracket		2
Bottom Bracket		2
Fixing Screw		4
Spacer		4
Air Vent		2
Vent cover		2

Description	Illustration
Fixings choose the appropriate fixing for the wall material if required	
PTFE tape	
Electric drill	
Masonry drill bit appropriate to the fixings	
Adjustable spanner	
Radiator valve Hex Key	
Flat head and Philips head screw drivers	
1 Lock shield valve and 1 Gate or Thermostatic valve	
Spirit level	
Measuring tape	

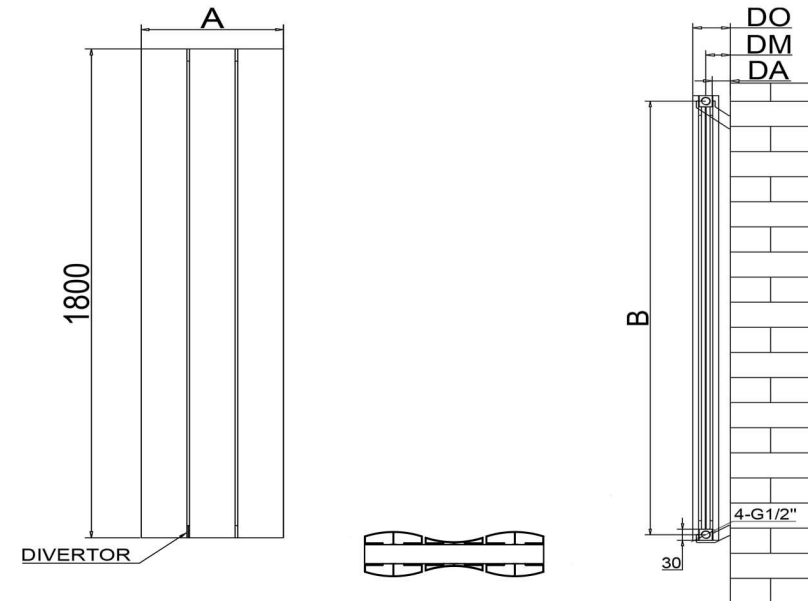

This picture represents appearance look of a radiator.

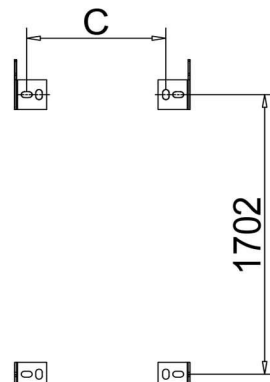
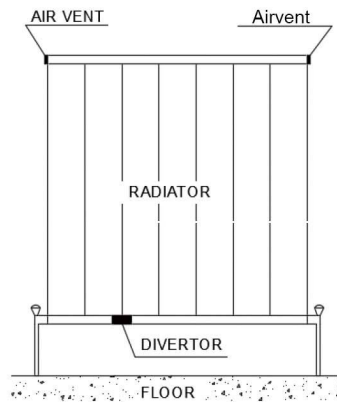

NAMES		A	B	C	TUBE QTY	DA	DM	DO
A-GI318AD	1800	280	1770	57.5	3	22	57	92
A-GI318WD	1800	280	1770	57.5	3	22	57	92
A-GI518AD	1800	470	1770	247.5	5	22	57	92
A-GI518WD	1800	470	1770	247.5	5	22	57	92
A-GI718AD	1800	660	1770	437.5	7	22	57	92
A-GI718WD	1800	660	1770	437.5	7	22	57	92

## GENERAL RECOMMENDATION

- Before fitting the radiator it is necessary to wash out the heating system to remove any existing mud, scale, work residues, traces of flux, oil, etc.
- When the system water pH is outside the 8,5-5,5 range and/or when the dissolved is above 0,1mg/liter, it is always needed to protect the heating system components (the radiator is one of these) with a proper chemical treatment compatible with all parts in contact with water (silicon rubber too).
- In order to fit the radiator to the wall, it is necessary to choose the proper fixings for the wall material.
- If the system water exceeds 50C, please install a warning mark near the radiator to avoid any accidental scalding.
- Clean the radiator surface only with a soft cloth to avoid scratching the finish and do not use chemical agents during cleaning operations. It is prohibited to climb on the radiator.
- Maximum working temperature 95C, maximum working pressure 4 bar.